

ACCESSORIES

Scoreboard
Displays



VISION BY DESIGN

VISION TIME

Model CDL-1-0202

COUNTDOWN DISPLAYS

SIZE: 2' x 2' 24" L x 24" H x 4.75" D	Power: 120V/220V 50/60 HZ 20 Watts	Installed Weight: Approx. 20 lbs/9 kg
---	--	---

DISPLAY FEATURES

- 13" digits for countdown timer
- Operates as a 30 second (or preset) countdown timer
- Horn sounds when the preset time has counted down to zero
- Mounting is via four keyed brackets

STANDARD FEATURES

- Standard colour is black. Other colours are available - contact your distributor or the factory.
- Standard caption language is English. Other languages are available - consult your distributor or the factory.
- 120 Volt 50/60 Hz power input

OPTIONS AVAILABLE

- 220 Volt 50/60 Hz operation
- 200 feet of cable.
- Wireless Control

WHEN ORDERING, PLEASE SPECIFY

- Model of display
- Colour (if other than black)
- Caption language (if other than English)
- Length of control cable (if longer than 200')
- Options required
- Input voltage preferred
- If a protective screen is required

2'-0"

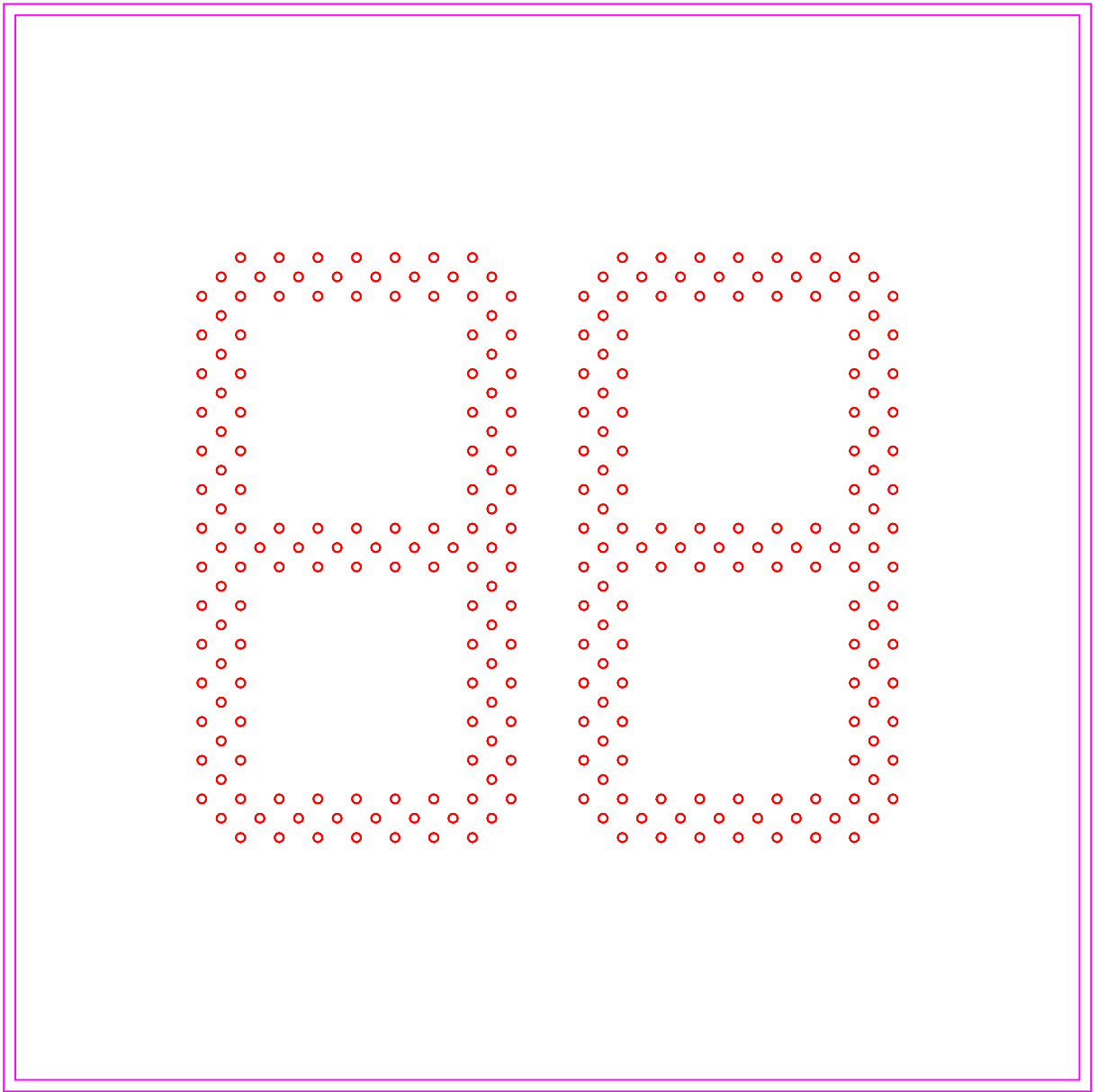

2'-0"

HDD HAMILTON DIGITAL DESIGNS LTD.	MODEL #	DIGIT SIZE	CAPTION SIZE
	CDL-01-0202	13"	N/A
	SIZE L=24" H=24"		



VISION BY DESIGN

VISION TIME

Model CDL-1-0402-1A

COUNTDOWN DISPLAYS WITH ADVERTISING PANEL

SIZE: 4'6" x 2' 54" L x 24" H x 4.75" D	Power: 120V/220V 50/60 HZ 137 Watts	Installed Weight: Approx. 45 lbs/20 kg
---	---	--

DISPLAY FEATURES

- 13" digits for countdown timer
- Operates as a 30 second (or preset) countdown timer
- Horn sounds when the preset time has counted down to zero
- Mounting is via four keyed brackets
- 17" x 25" illuminated advertising panel

STANDARD FEATURES

- Standard colour is black. Other colours are available - contact your distributor or the factory
- Standard caption language is English. Other languages are available - consult your distributor or the factory.
- 200 feet of cable is included with each scoreboard.
- 120 Volt 50/60 Hz power input

OPTIONS AVAILABLE

- 220 Volt 50/60 Hz operation
- Non-illuminated advertising panel
- Wireless control

WHEN ORDERING, PLEASE SPECIFY

- Model of display
- Colour (if other than black)
- Caption language (if other than English)
- Length of control cable (if longer than 200')
- Options required
- Input voltage preferred
- If a protective screen is required

Advertising panels are shipped without graphics. We will be pleased to quote your graphics artwork.

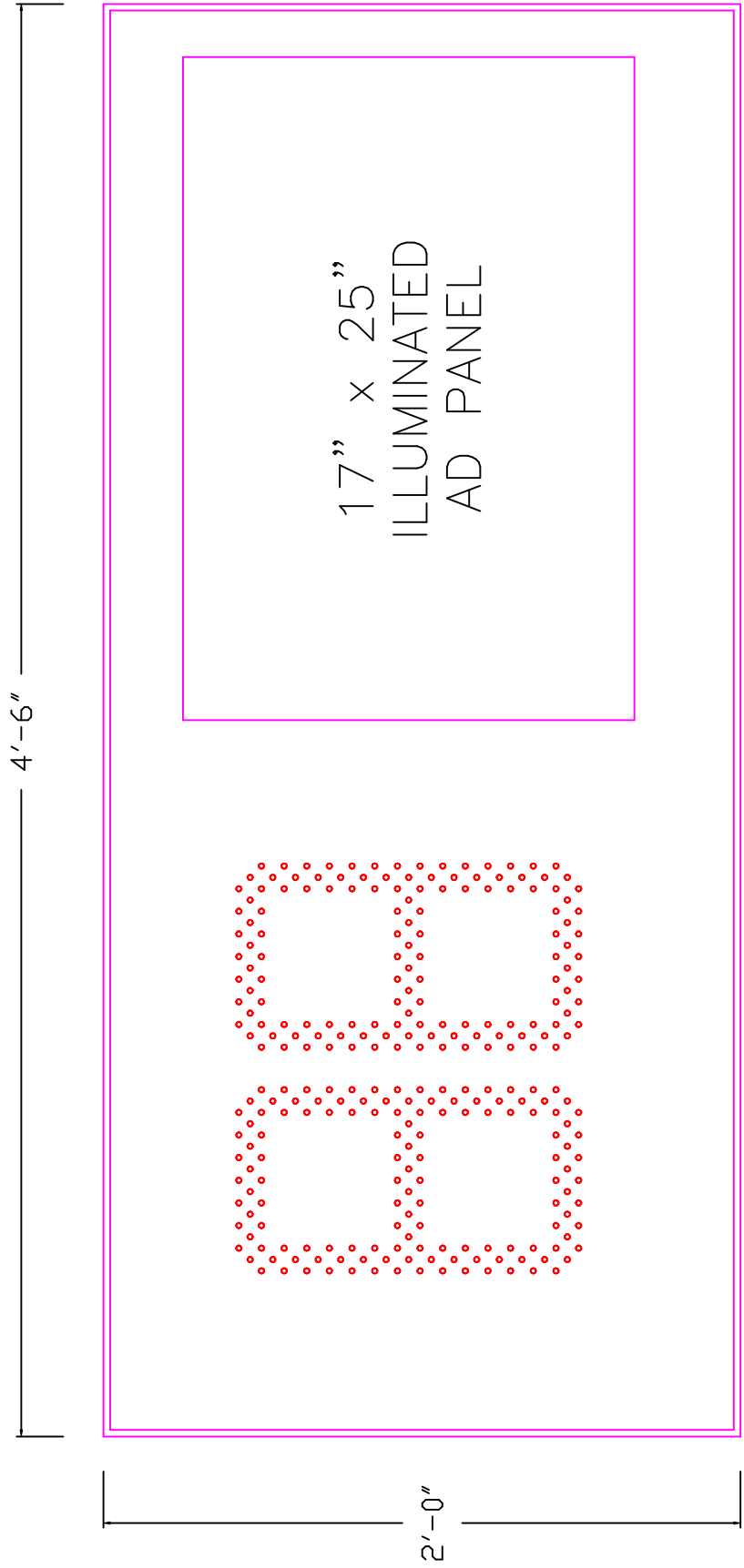

HAMILTON DIGITAL
DESIGNS LTD.

MODEL #	CDL-01-0402-1A	DIGIT SIZE	13"	CAPTION SIZE	N/A
SIZE	L=54" H=24"				



VISION BY DESIGN

VISION TIME

Model CDL-2-0303

COUNTDOWN DISPLAYS WITH GAME TIME

SIZE: 3' x 3'4" 36" L x 40" H x 4.75" D	Power: 120V/220V 50/60 HZ 171 Watts	Installed Weight: Approx. 50 lbs/23kg (each)
---	---	--

DISPLAY FEATURES

- 13" digits for countdown timer
- 10" digits for game time
- Operates as a 30 second (or preset) countdown timer
- Horn sounds when the preset time has counted down to zero
- Mounting is via four keyed brackets

STANDARD FEATURES

- Standard colour is black. Other colours are available - contact your distributor or the factory
- Standard caption language is English. Other languages are available - consult your distributor or the factory.
- 200 feet of cable is included with each scoreboard.
- 120 Volt 50/60 Hz power input

OPTIONS AVAILABLE

- 220 Volt 50/60 Hz operation
- Wireless control

WHEN ORDERING, PLEASE SPECIFY

- Model of display
- Colour (if other than black)
- Caption language (if other than English)
- Length of control cable (if longer than 200')
- Options required
- Input voltage preferred
- If a protective screen is required

3'-0"

3'-4"

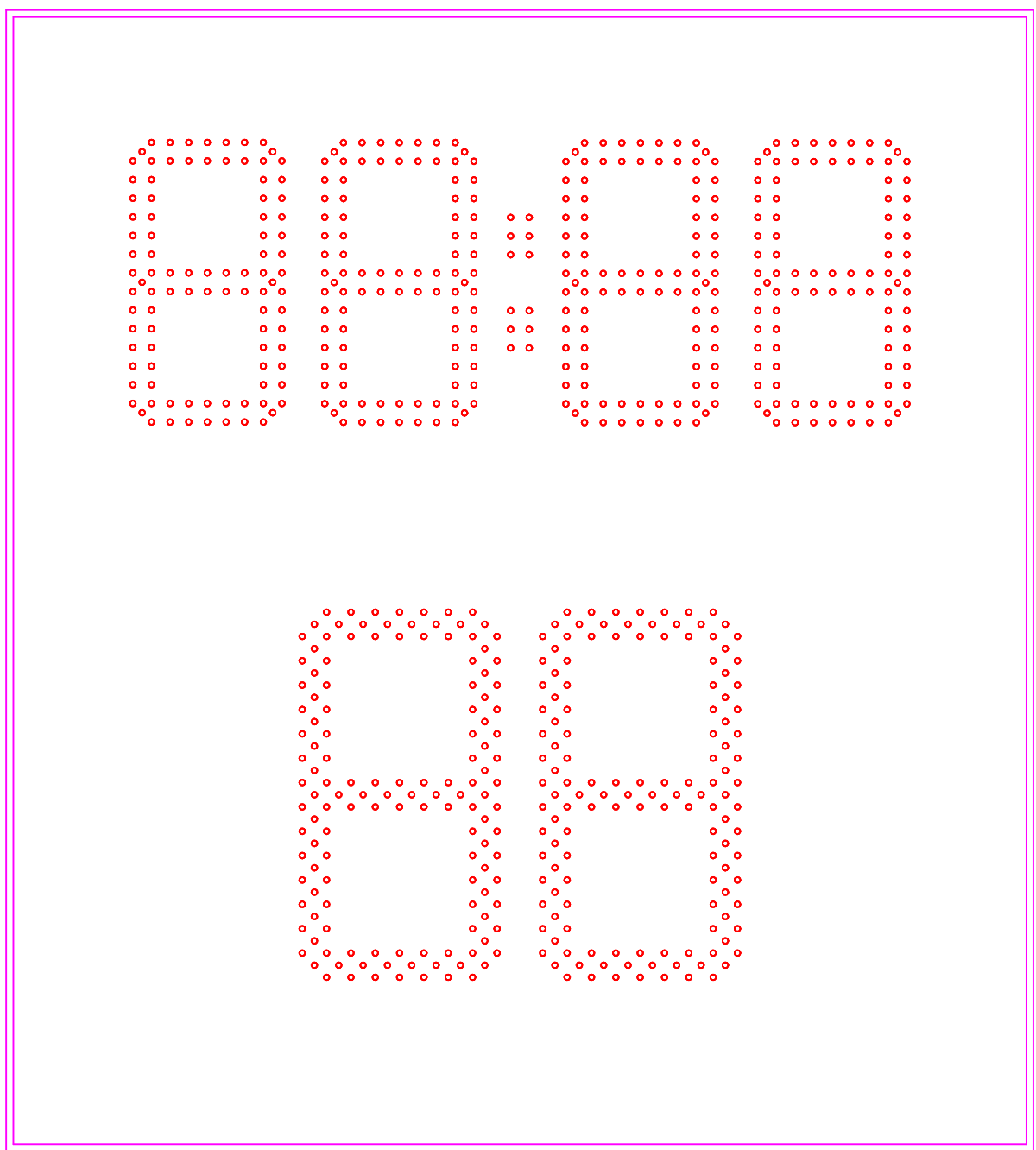

HDD HAMILTON DIGITAL DESIGNS LTD.	MODEL #	DIGIT SIZE	CAPTION SIZE
	CDL-02-0303	13" & 10"	N/A
	SIZE L=36" H=40"		



VISION BY DESIGN

VISION TIME

Model IT-1-0402

ICE TIMER /CURFEW CLOCK

SIZE: 3'11" x 2'3" 47" L x 27" H x 4.75" D	Power: 120V/220V 50/60 HZ 42 Watts	Installed Weight: Approx. 45 lbs/20 kg
--	--	--

DISPLAY FEATURES

- 13" digits
- Operates as a time up or time down timer (99:59) or a time of day clock
- When operated as a timer, horn sounds when the preset time is reached
- Wireless remote control allows for easy resetting or adjusting
- Mounting is via four keyed brackets

CAPTION HEIGHT

ICE TIMER 3"

STANDARD FEATURES

- Standard colour is black. Other colours are available - contact your distributor or the factory.
- 120 Volt 50/60 Hz power input.
- For operator **SAFETY**, HDD's standard controller does not require AC power.

OPTIONS AVAILABLE

- 220 Volt 50/60 Hz operation
- Illuminated advertising panel
- 24 hour format for time-of-day display
- Standard controller with 200' of cable

WHEN ORDERING, PLEASE SPECIFY

- Model of display
- Colour (if other than black)
- Length of control cable (if longer than 200')
- Options required
- Input voltage preferred
- If a protective screen is required

3'-11"

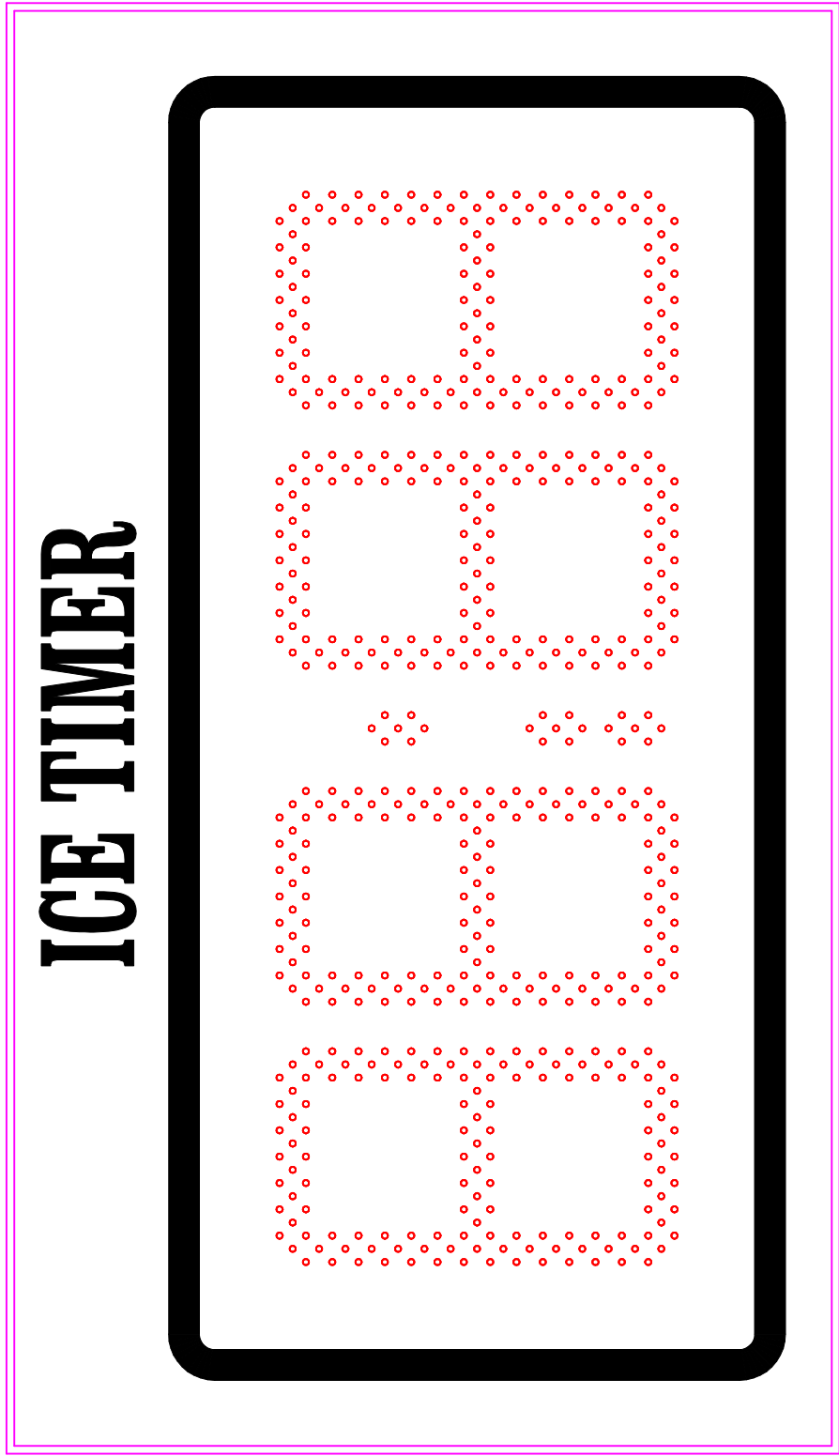

2'-3"

HDD HAMILTON DIGITAL DESIGNS LTD.	MODEL #	DIGIT SIZE	CAPTION SIZE
	IT-1-0402	13"	3"
	SIZE L=47" H=27"		



VISION BY DESIGN

VISION TIME

Model SOG-1-0602

SHOTS ON GOAL DISPLAY

SIZE: 6' x 2'6" 72" L x 30" H x 4.75" D	Power: 120V/220V 50/60 HZ 40 Watts	Installed Weight: Approx. 75 lbs/34 kg
---	--	--

DISPLAY FEATURES

- 13" digits
- Displays shots on goal to 99 per team
- Wireless remote control allows for easy resetting or adjusting
- Mounting is via four keyed brackets

CAPTION HEIGHTS

HOME	5"
GUEST	5"
SHOTS ON GOAL	3"

STANDARD FEATURES

- Standard colour is black with white captions. Other colours are available - contact your distributor or the factory
- Standard caption language is English. Other languages are available - consult your distributor or the factory.
- 120 Volt 50/60 Hz power input
- For operator **SAFETY**, HDD's standard controller does not require AC power.

OPTIONS AVAILABLE

- 220 Volt 50/60 Hz operation
- Standard Controller with 200' of cable.

WHEN ORDERING, PLEASE SPECIFY

- Model of display
- Colour (if other than black)
- Caption language (if other than English)
- Length of control cable (if longer than 200')
- Options required
- Input voltage preferred
- If a protective screen is required

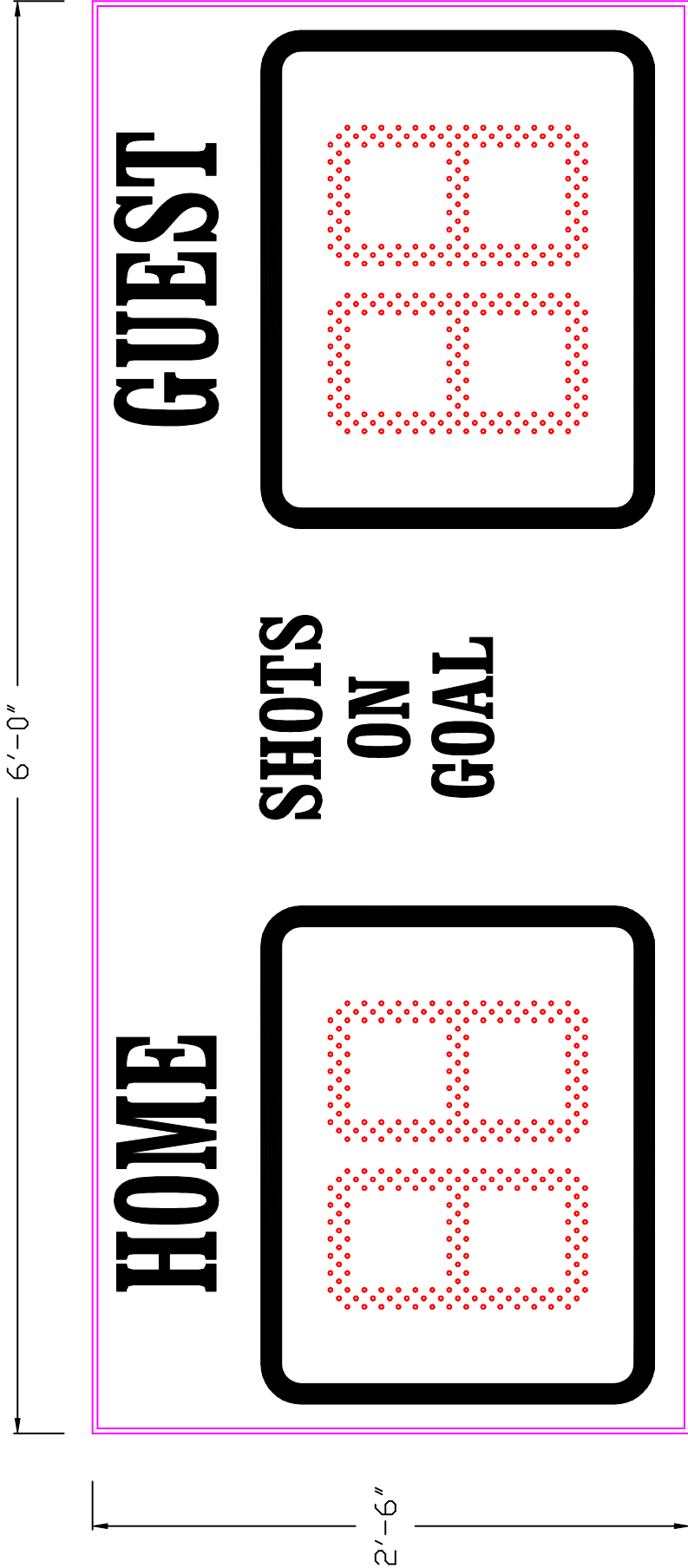

6'-0"

2'-6"

GUEST

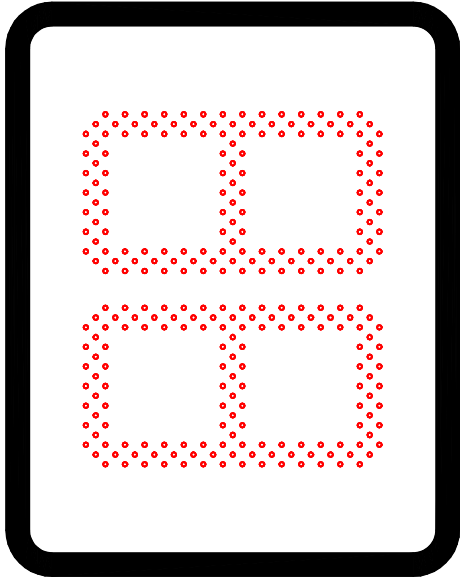

**SHOTS
ON
GOAL**

HOME

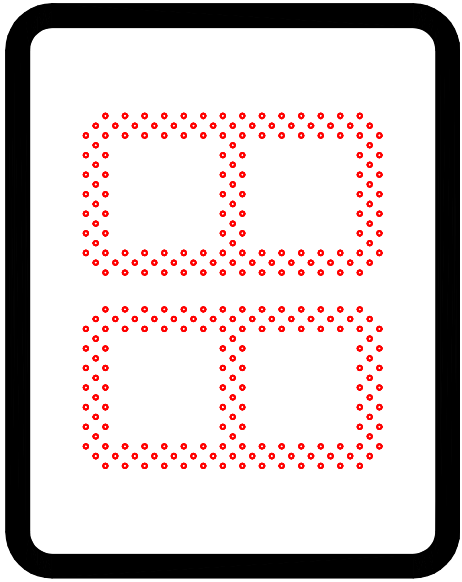

 HAMILTON DIGITAL DESIGNS LTD.	MODEL #	DIGIT SIZE	CAPTION SIZE
	SOG-1-0602	13"	5" & 3"
	SIZE L=72" H=30"		



VISION BY DESIGN

VISION TIME

Model SOG-1-0803-1A

SHOTS ON GOAL DISPLAY WITH ADVERTISING PANEL

SIZE: 7'6" x 3' 90" L x 36" H x 4.75" D	Power: 120V/220V 50/60 HZ 157 Watts	Installed Weight: Approx. 115 lbs/55 kg
---	---	---

DISPLAY FEATURES

- 13" digits
- Displays shots on goal to 99 per team
- Mounting is via four keyed brackets
- Includes one 23" x 35" illuminated advertising panel

CAPTION HEIGHTS

HOME	5"
GUEST	5"
SHOTS	3"

STANDARD FEATURES

- Standard colour is black with white captions. Other colours are available - contact your distributor or the factory
- Standard caption language is English. Other languages are available - consult your distributor or the factory.
- Standard controller with 200 feet of cable.
- For operator **SAFETY**, HDD's standard controller does not require AC power.
- 120 Volt 50/60 Hz power input

OPTIONS AVAILABLE

- 220 Volt 50/60 Hz operation
- Non-illuminated advertising panel
- No SHOTS caption, allowing display to be general purpose

WHEN ORDERING, PLEASE SPECIFY

- Model of display
- Colour (if other than black)
- Caption language (if other than English)
- Length of control cable (if longer than 200')
- Options required
- Input voltage preferred
- If a protective screen is required

Advertising panels are shipped without graphics. We will be pleased to quote your graphics artwork.

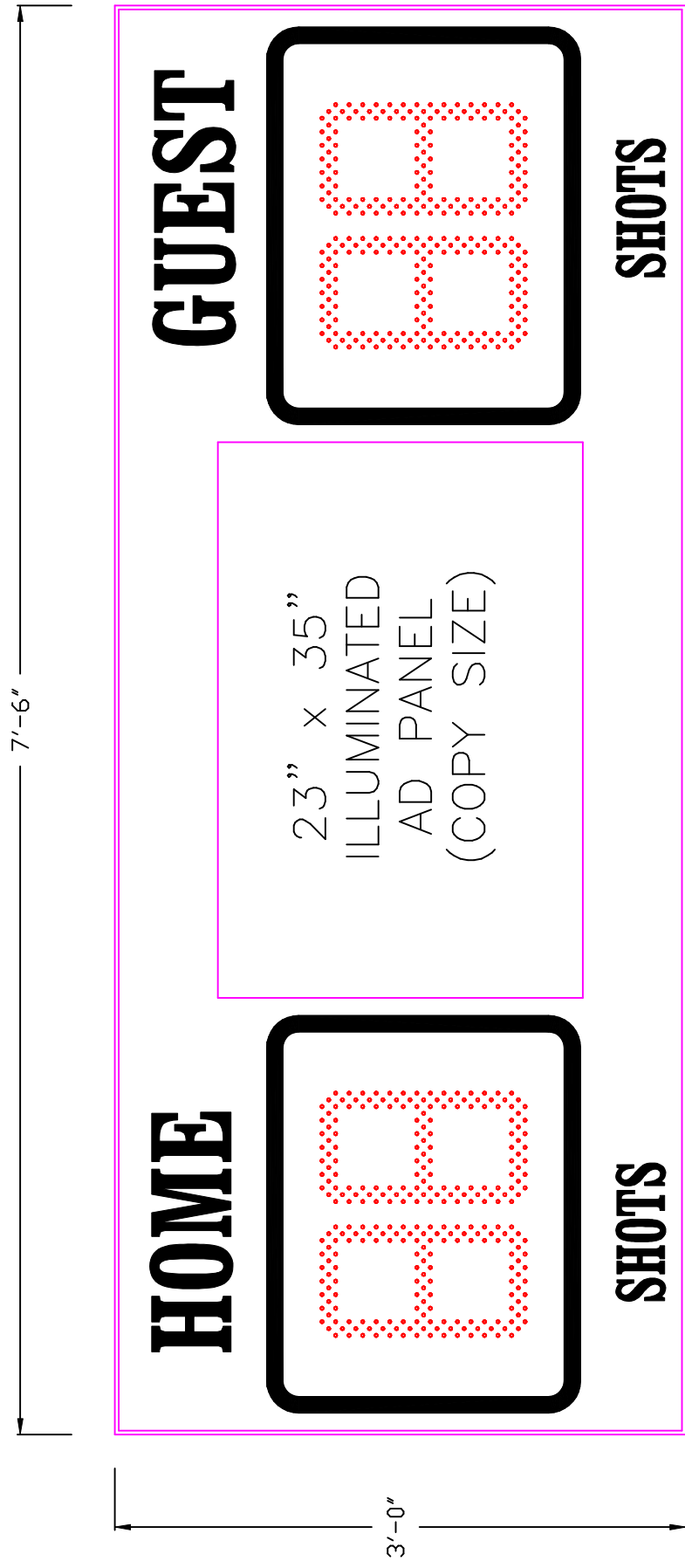

HAMILTON DIGITAL
DESIGNS LTD.

MODEL #	DIGIT SIZE	CAPTION SIZE
SOG-1-0803-1A	13"	5" & 3"
SIZE		
L=90" H=36"		



VISION BY DESIGN

VISION TIME

Model SOG-1-1202-2A

SHOTS ON GOAL DISPLAY WITH TWO ADVERTISING PANELS

SIZE: 12'3" x 2'6" 147" L x 30" H x 4.75" D	Power: 120V/220V 50/60 HZ 275 Watts	Installed Weight: Approx. 155 lbs/70 kg
---	---	---

DISPLAY FEATURES

- 13" digits
- Displays shots on goal to 99 per team
- Mounting is via eight keyed brackets
- Two 27.5" x 35" illuminated advertising panel

CAPTION HEIGHTS

HOME	5"
GUEST	5"
SHOTS ON GOAL	3"

STANDARD FEATURES

- Standard colour is black with white captions. Other colours are available – contact your distributor or the factory
- Standard caption language is English. Other languages are available – consult your distributor or the factory.
- Controller and 200' of cable.
- For operator **SAFETY**, HDD's standard controller does not require AC power.
- 120 Volt 50/60 Hz power input

OPTIONS AVAILABLE

- 220 Volt 50/60 Hz operation
- Non-illuminated advertising panels

WHEN ORDERING, PLEASE SPECIFY

- Model of display
- Colour (if other than black)
- Caption language (if other than English)
- Length of control cable (if longer than 200')
- Options required
- Input voltage preferred
- If a protective screen is required

Advertising panels are shipped without graphics. We will be pleased to quote your graphics artwork.

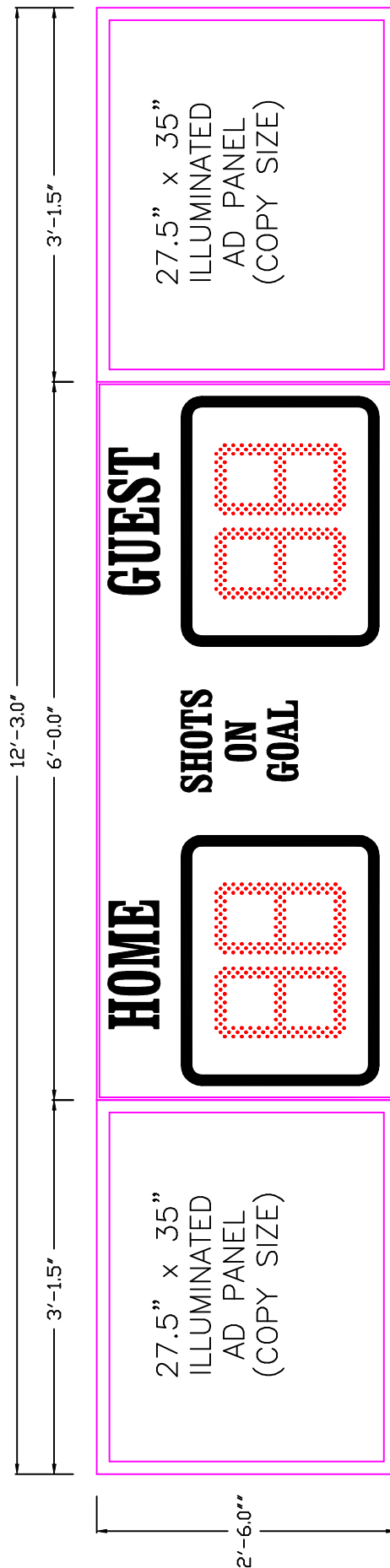

 HAMILTON DIGITAL DESIGNS LTD.	MODEL #	DIGIT SIZE	CAPTION SIZE
	SOG-1-1202-2A	13"	5" & 3"
	SIZE L=147" H=30"		



VISION BY DESIGN

VISION TIME

Model TOD-1-0402

TIME OF DAY CLOCK

SIZE: 3'11" x 1'10" 47" L x 22" H x 4.75" D	Power: 120V/220V 50/60 HZ 42 Watts	Installed Weight: Approx. 40 lbs/18 kg
---	--	--

DISPLAY FEATURES

- 13" digits
- 12 hour clock format standard
- Time set buttons located on side of housing
- Mounting is via four keyed brackets

STANDARD FEATURES

- Standard colour is black. Other colours are available - contact your distributor or the factory.
- 120 Volt 50/60 Hz power input.
- For operator **SAFETY**, HDD's standard controller does not require AC power.

OPTIONS AVAILABLE

- 220 Volt 50/60 Hz operation
- 24 hour format
- Remote time setting buttons
- Standard controller with 200' of cable

WHEN ORDERING, PLEASE SPECIFY

- Model of display
- Colour (if other than black)
- Length of control cable (if remote operation required)
- Options required
- Input voltage preferred
- If a protective screen is required

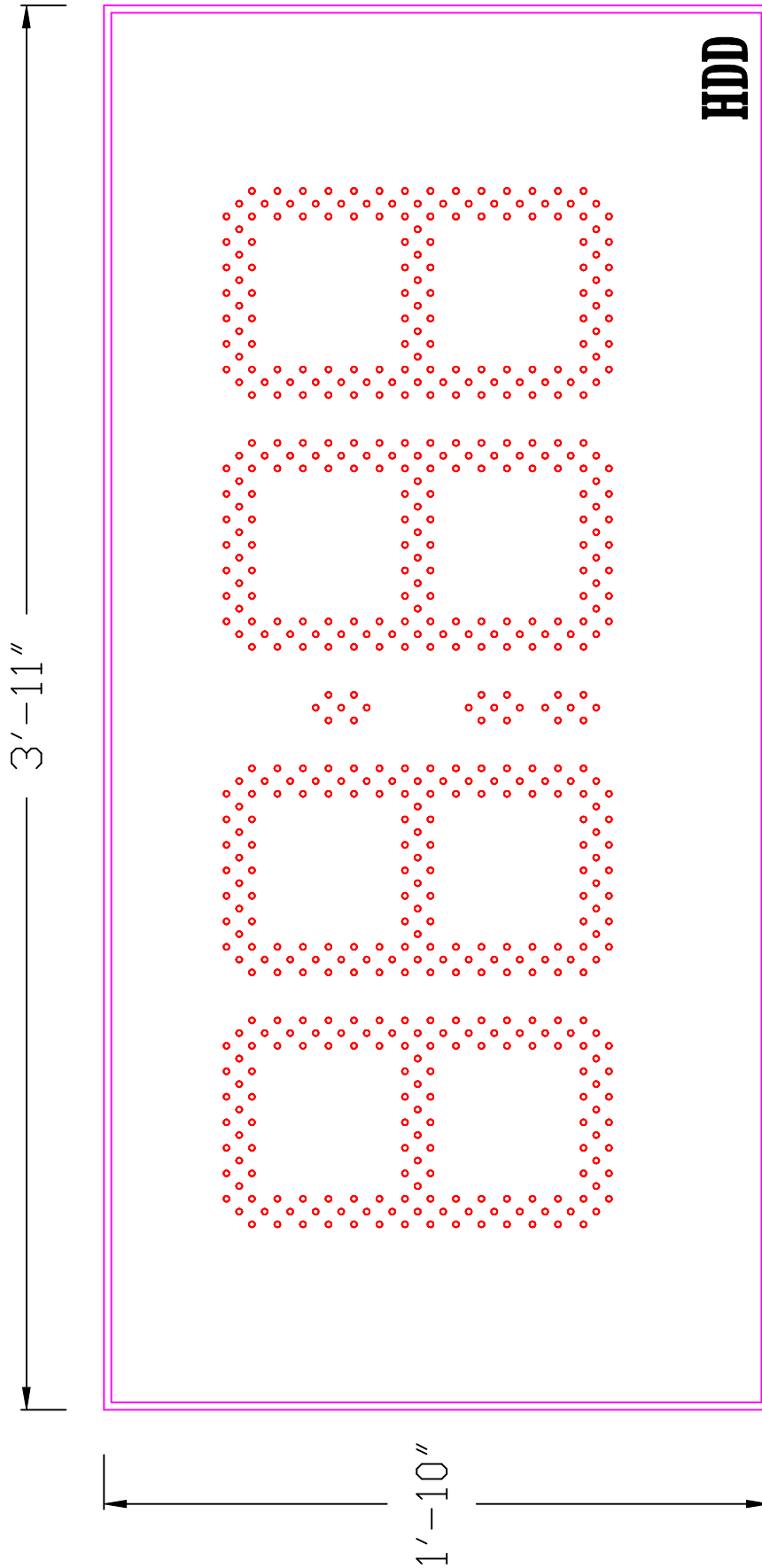

 HAMILTON DIGITAL DESIGNS LTD.	MODEL #	DIGIT SIZE	CAPTION SIZE
	TOD-1-0402	13"	
	SIZE		
	L=47" H=22"		



VISION BY DESIGN

VISION TIME

Model TOD-1-0404-1A

TIME OF DAY CLOCK WITH 1 AD PANEL

SIZE: 3'11" x 3'11" 47" L x 47" H x 4.75" D	Power: 120V/220V 50/60 HZ 42 Watts	Installed Weight: Approx. 85 lbs/39 kg
---	--	--

DISPLAY FEATURES

- 13" digits
- 12 hour clock format standard
- Time set buttons located on side of housing
- Mounting is via four keyed brackets
- 23" x 35" illuminated advertising panel

STANDARD FEATURES

- Standard colour is black. Other colours are available - contact your distributor or the factory.
- 120 Volt 50/60 Hz power input.
- For operator **SAFETY**, HDD's standard controller does not require AC power.

OPTIONS AVAILABLE

- 220 Volt 50/60 Hz operation
- 24 hour format
- Remote time setting buttons

WHEN ORDERING, PLEASE SPECIFY

- Model of display
- Colour (if other than black)
- Length of control cable (if remote operation required)
- Options required
- Input voltage preferred
- If a protective screen is required

Advertising panels are shipped without graphics; We will be pleased to quote our graphics artwork.

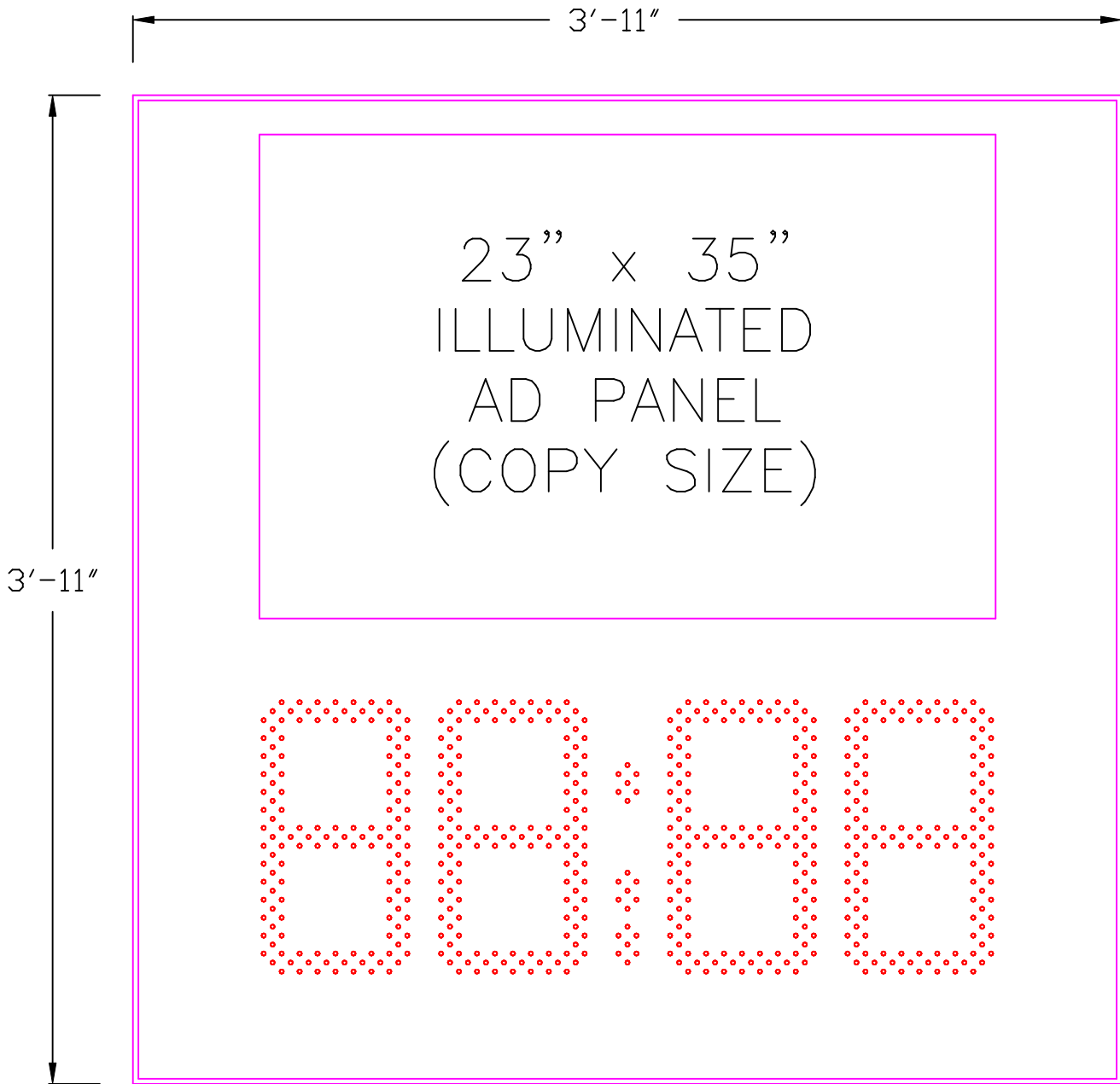

 HAMILTON DIGITAL DESIGNS LTD.	MODEL #	DIGIT SIZE	CAPTION SIZE
	TOD-1-0404-1A	13"	N/A
	SIZE L=47" H=47"		